

AAT3604B

Total Power Solution for Micro Power Applications

General Description

The AAT3604B is a micropower PMU optimized for maximum lithium-ion (polymer) battery life both in operational and standby mode. The total no load current into V_{IN} when all functions are enabled is only 70 μ A.

The AAT3604B is a highly integrated device which simplifies system level design for the user with minimal external components required. It contains a step-up (boost) converter, a step-down (buck) converter, an LDO regulator and a single-cell Lithium Ion/Polymer battery charger in a single PMU. The device also includes a load switch for dynamic power path/sleep mode operation for processor core voltage, making it ideal for ultra low power portable devices.

The battery charger is a complete, thermally protected constant current/constant voltage linear charger. It includes an integrated pass device, reverse blocking protection, high accuracy current and voltage regulation, charge status indication, and charge termination. The step-up DC/DC converter is a high efficiency boost converter capable of 27V maximum output voltage. It is the ideal power solution to power OLED, LCD, and CCD applications. The step-up converter offers a true load disconnect feature which isolates the load from the power source when EN1 is pulled low. This eliminates leakage current and isolates the output while the device is disabled.

The step-down DC/DC converter is integrated with internal compensation and operates up to a switching frequency of 1.6MHz, thus minimizing the size of external components while keeping switching losses low and efficiency high.

The LDO regulator offers 60dB power supply rejection ratio (PSRR) and low noise operation, making it suitable for powering noise-sensitive loads.

The AAT3604B is available in a space-saving, thermally enhanced 24-pin QFN44 package.

Features/Performance

- V_{IN} : 2.7V to 5.5V
- Minimum External Components
- Less than 1.1mm Height for all External Components
- Total Standby Mode Ground Current 1 μ A (VO1, VO2, and VO3 enabled).
- 1.8V Enable Logic
- Core Voltage Switchover in Standby Mode
- LDO Input Current Minimized for 5 μ A Typical Load
- Buck Efficiency Optimized for 0.6mA Load
- Separate Enable Pins for Each Supply Output
- Over-Current Protection
- Over-Temperature Protection
- 24-Pin 4x4 QFN package

Step-Up (Boost) Converter

- 6.0 to 10V @ 2mA Output

Step-Down (Buck) Converter

- 0.6V to V_{IN} @ 25mA Output

LDO Regulator (AUX)

- 2.0 to 2.6V/5mA @ $V_{IN} = 3.6V$
- PSRR: 60dB@100Hz
- Noise: 175 μ Vrms

Battery Charger (3.0V)

- Lithium-Ion/Polymer Battery Charger
- Digitized Thermal Regulation
- Charge Current Programming up to 100mA
- Charge Current Termination Programming
- Automatic Trickle Charge for Battery Preconditioning
- Charge Status Indicator

Applications

- 3D Goggles
- GPS Tracking Units
- Remote Sensors
- Spy Modules

AAT3604B

Total Power Solution for Micro Power Applications

Typical Application

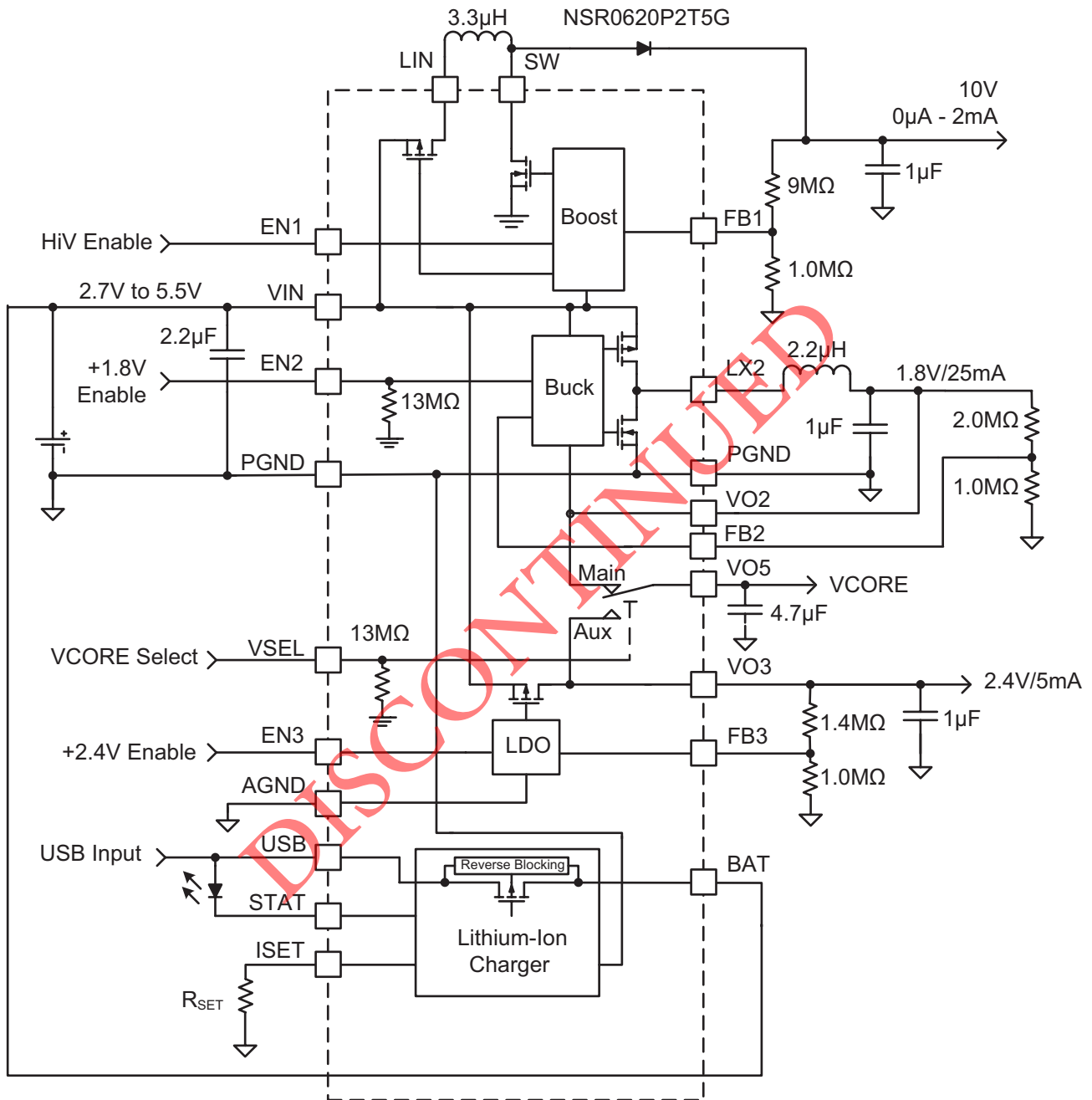

AAT3604B

Total Power Solution for Micro Power Applications

Pin Descriptions

Pin #	Symbol	Function
1	FB1	Boost converter feedback voltage.
2	AGND	System small signal ground.
3	EN2	Active high buck converter enable.
4	EN1	Active high boost converter enable input.
5	USB	USB source for battery charger. Should be decoupled with 2.2μF or greater capacitor.
6	FB2	Buck converter feedback voltage.
7	BAT	Battery connection.
8	ISET	Battery charge current set. Programs the charge current by terminating with a resistor to ground.
9	STAT	Battery charge status output.
10, 11, 12	N/C	No connection.
13	VSEL	Core voltage select logic input. VSEL = 0, VO5 = VO3; VSEL = 1, VO5 = VO2.
14	AGND	System small signal ground.
15	EN3	Active high nano power LDO regulator enable.
16	FB3	Nano power LDO regulator feedback.
17	VO3	Nano power linear regulator output voltage. Should be decoupled with 1μF or greater output capacitor.
18	VO5	Core voltage.
19	VO2	Buck converter output voltage.
20	SW	Boost switch node.
21	PGND	Power ground.
22	LX2	Buck converter switch node.
23	VIN	Input voltage. Should be decoupled with 2.2μF or greater capacitor.
24	LIN	Boost switched power input voltage.
EP	EP	Exposed pad; connect to ground plane.

Pin Configuration

QFN44-24
(Top View)

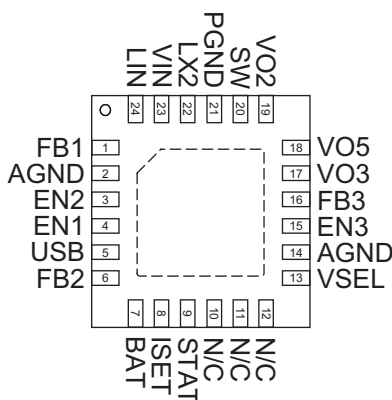

AAT3604B*Total Power Solution for Micro Power Applications***Absolute Maximum Ratings¹**

Symbol	Description	Value	Units
VIN, BAT	Input Voltage and Bias Power to PGND	6.0	V
LIN	Boost Inductor Source to PGND	32	
USB	USB Battery Charger Input	7.5	
V _{SW}	SW to PGND	-0.3 to 30	
V _{LX21}	LX1 to GND	-0.3 to 6	
V _{FB1} , V _{FB2} , V _{FB3}	FB1, FB2, FB3 to GND	-0.3 to V _{INB} + 0.3	
VSEL, EN1-EN3, STAT, ISET	Logic Levels	-0.3 to V _{INB} + 0.3	°C
T _J	Operating Junction Temperature Range	-40 to 150	
T _{LEAD}	Maximum Soldering Temperature (at leads, 10 sec.)	300	

Thermal Information

Symbol	Description	Value	Units
P _D	Maximum Power Dissipation	2	W
Θ _{JA}	Thermal Resistance ²	50	°C/W

DISCONTINUED

1. Stresses above those listed in Absolute Maximum Ratings may cause permanent damage to the device. Functional operation at conditions other than the operating conditions specified is not implied.
2. Mounted on a FR4 board.

AAT3604B*Total Power Solution for Micro Power Applications***Electrical Characteristics****Buck Converter**T_A = 0°C to 70°C, unless otherwise noted. Typical values are T_A = 25°C, V_{IN} = 3.6V.

Symbol	Description	Conditions	Min	Typ	Max	Units
V _{IN}	Input Voltage		2.7		4.5	V
V _{O2}	Output Voltage Range		0.6		V _{IN}	V
I _{OUTMAX}	Maximum Output Current ¹	V _{IN} = 2.7 to 4.5V @ V _{OUT} = 1.8V	25			mA
V _{O2}	Output Voltage Tolerance	I _{O2} = 0mA to 5mA, V _{IN} = 2.7V to 4.5V, T _A = 25°C	-3.0		+3.0	%
η	Efficiency	I _{O2} = 1.0mA, V _{O2} = 1.8V		85		%
I _{IN}	Input Current	V _{O2} = 1.8V, I _{OUT} = 0.6mA		350		μA
I _Q	Quiescent Current	No Load		25		μA
I _{SYSSHDN}	System Shutdown Current	EN2 = 0V, V _{IN} = 2.7V to 4.2V			2.0	μA
I _{LIM}	P-Channel Peak Current Limit			750		mA
R _{DS(ON)L}	High Side Switch On-Resistance			1		Ω
R _{DS(ON)H}	Low Side Switch On-Resistance			1		Ω
$\frac{\Delta V_{O2}}{V_{O2}} \cdot \Delta V_{IN}$	Line Regulation	V _{IN} = 2.7V to 4.5V		0.1		%/V
I _{FB2}	FB Leakage Current	V _{O2} = 1.0V		1		nA
F _{OSC}	Maximum Switching Frequency			1.6		MHz
T _{SD}	Over-Temperature Shutdown Threshold			140		°C
T _{HYS}	Over-Temperature Shutdown Hysteresis			25		°C
Active High Enable Logic Input						
V _{EN2(L)}	Enable Threshold Low				0.4	V
V _{EN2(H)}	Enable Threshold High		1.4			V
I _{EN2}	Enable Input Low Current	V _{IN} = 4.2V, V _{EN2} = GND			1	μA

LDO RegulatorT_A = 0°C to 70°C, unless otherwise noted. Typical values are T_A = 25°C, V_{IN} = 3.6V, C_{OUT} = 0.1μF

Symbol	Description	Conditions	Min	Typ	Max	Units
V _{IN}	Input Voltage		2.7		4.5	V
V _{O3}	Output Voltage Range	External Resistor Programmable	2.0		2.6	V
ΔV _{OUT}	Output Voltage Tolerance	I _{O3} = 0 to 100μA, V _{IN} = 2.7V to 4.5V	-3		+3	% V _{OUT}
I _{O3MAX}	Maximum Output Current	V _{O3} = 2.0V, V _{IN} = 3.6V	5			mA
V _{DO}	Dropout Voltage ¹	I _{OUT} = 100μA		17		mV
I _{SC}	Short-Circuit Current	V _{OUT} < 0.4V		12		mA
I _Q	Ground Current	V _{IN} = 2.7V to 3.6V, No Load		1.5	3.5	μA
ΔV _{O3} /ΔV _{IN}	Line Regulation	V _{IN} = 2.7 to 4.5V		0.02		%
ΔV _{O3(Load) / V_{O3}}	Load Regulation	I _{O3} = 0μA to 100μA		0.05		%
PSRR	Power Supply Rejection Ratio	100Hz		60		dB
e _N	Output Noise	100Hz to 100kHz @ 1mA		175		μV _{RMS}
Active High LDO Enable Input						
V _{EN3(L)}	Enable Threshold Low				0.4	V
V _{EN3(H)}	Enable Threshold High		1.4			V
I _{EN3}	Enable Input Low Current	V _{IN} = 4.2V, V _{EN3} = GND			1	μA

1. The AAT3604B is guaranteed to meet performance specification from 0°C to +70°C and is assured by design, characterization and correlation with statistical process controls.

Total Power Solution for Micro Power Applications

Electrical Characteristics (continued)

Boost Converter

$V_{IN} = 3.6V$, $V_{OUT} = 27V$, $T_A = 0^\circ C$ to $70^\circ C$ unless otherwise noted. Typical values are at $T_A = 25^\circ C$.

Symbol	Description	Conditions	Min	Typ	Max	Units
Boost						
V_{IN}	Input Voltage Range	$I_{OUT} = 0$ to $200\mu A$	2.7		4.5	V
V_{OUT}	Output Voltage Adjustment Range		6		27	V
V_{OUT}	Output Voltage Tolerance	$V_{IN} = 2.7V$ to $4.5V$	-3		+3	%
V_{PK}	Peak to Peak Output Voltage Ripple			100		mV
I_{OUT}	Load Current Range	$V_{IN} = 2.7V$ to $4.5V$, $V_{OUT} = 6V$ to $27V$		50	200	μA
I_{OUT}	Load Current Range ¹	$V_{IN} = 2.7V$ to $4.5V$, $V_{OUT} = 6V$ to $10V$			2	mA
I_{PG}	Fixed Peak Cycle by Cycle Inductor Current Limit			600		mA
I_Q	Quiescent Supply Current (No Switching)	$V_{FB} = 1.5V$		16		μA
I_{SHDN}	Shutdown Current	$EN1 = GND$, $V_{IN} = 2.7V$ to $4.2V$		1.0		μA
$R_{DS(ON)L}$	NMOS On-Resistance	$T_A = 25^\circ C$, $V_{IN} = 3.6V$		0.6		Ω
η	Efficiency	$I_{OUT} = 50\mu A$, $L = 10\mu H$, $V_{IN} = 3.6V$, $V_{OUT} = 27V$		73		%
		$I_{OUT} = 2mA$, $L = 3.3\mu H$, $V_{IN} = 3.6V$, $V_{OUT} = 10V$		85		%
ΔV_{OUT}	Load Regulation	$I_{OUT} = 0$ to $200\mu A$		0.1		%
ΔV_{OUT}	Line Regulation	$V_{IN} = 2.7V$ to $4.5V$		0.1		%
$F_{OSC(MAX)}$	Typical Maximum Switching Frequency	$T_A = 25^\circ C$, $I_{OUT} = 200\mu A$		0.12		MHz
$F_{OSC(MIN)}$	Typical Minimum Switching Frequency	$T_A = 25^\circ C$, $I_{OUT} = 1\mu A$		0.5		kHz
Active High Enable Input (EN)						
$V_{EN1(L)}$	Enable Threshold Low				0.4	V
$V_{EN1(H)}$	Enable Threshold High		1.4			V
I_{EN1}	Enable Input Low Current	$V_{IN} = 4.2V$, $V_{EN5} = GND$			1	μA

VCORE Select

$V_{IN} = 3.6V$, $T_A = 0^\circ C$ to $70^\circ C$ unless otherwise noted. Typical values are at $T_A = 25^\circ C$.

Symbol	Description	Conditions	Min	Typ	Max	Units
VSEL Logic and Switch Characteristics						
R_{SWA}	Resistance from VO2 to VO5	$V_{SEL} = High$		5		Ω
R_{SWB}	Resistance from VO3 to VO5	$V_{SEL} = Low$		35		Ω
I_{VO5}	VO5 Load Current			25		mA
V_{SELL}	Low Threshold				0.4	V
V_{SELH}	High Threshold		1.4			V
I_{SEL}	VCORE Select Logic Input Current	$V_{IN} = 4.2V$, $V_{SEL} = GND$			1.0	μA

1. The AAT3604B is guaranteed to meet performance specification from $0^\circ C$ to $+70^\circ C$ and is assured by design, characterization and correlation with statistical process controls.

Electrical Characteristics (continued)

Lithium-Ion Charger

$V_{USB} = 5V$, $T_A = 0^{\circ}C$ to $70^{\circ}C$ unless otherwise noted. Typical values are at $T_A = 25^{\circ}C$.

Symbol	Description	Conditions	Min	Typ	Max	Units
Charger Characteristics						
V_{USB}	USB Voltage Range		4.0		6.5	V
V_{UVLO}	Under-Voltage Lockout (UVLO)	Rising Edge		3.5		V
	UVLO Hysteresis			150		mV
I_{OP}	Operating Current	Charge Current = 25mA		0.5		mA
$I_{SHUTDOWN}$	USB Shutdown Current	$V_{BAT} = 4.25V$		0.3		μA
$I_{LEAKAGE}$	Reverse Leakage Current from BAT Pin	$V_{BAT} = 4V$, USB Pin Open		0.4		μA
Voltage Regulation						
V_{BAT_EOC}	End of Charge Accuracy		4.158	4.20	4.242	V
$\Delta V_{CH}/V_{CH}$	Output Charge Voltage Tolerance			0.5		%
V_{MIN}	Preconditioning Voltage Threshold			3.0		V
V_{RCH}	Battery Recharge Voltage Threshold	Measured from V_{BAT_EOC}		-0.1		V
Current Regulation						
I_{CH}	Charge Current Programmable Range		5		100	mA
$\Delta I_{CH}/I_{CH}$	Charge Current Regulation Tolerance			10		%
V_{SET}	I_{SET} Pin Voltage			2		V
KI_A	Current Set Factor: I_{CH}/I_{SET}			120		mA/mA
Charging Device						
$R_{DS(ON)}$	Charging Transistor ON Resistance	$V_{IN} = 5.5V$		2.5		Ω
Logic Control / Protection						
V_{STAT}	Output Low Voltage	STAT Pin Sinks 4mA			0.4	V
V_{OVP}	Battery Over-Voltage Protection Threshold			4.4		V
I_{TK}/I_{CHG}	Pre-Charge Current	$I_{SET} = 25mA$		10		%
I_{TERM}/I_{CH}	Charge Termination Threshold Current			10		%

Typical Characteristics – LDO Regulator

LDO Load Regulation vs. Output Current
($V_{OUT} = 2.5V$)

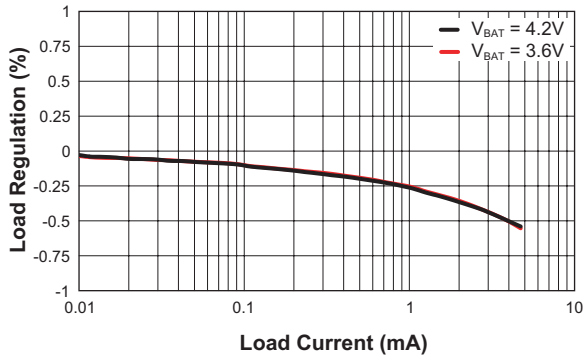

Dropout Voltage vs. Temperature
($I_{LOAD} = 100\mu A$)

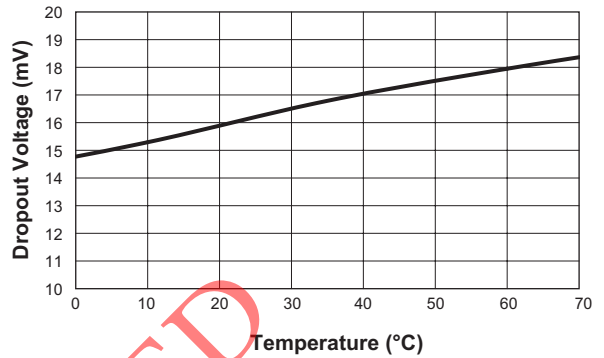

Output Voltage Error vs. Temperature

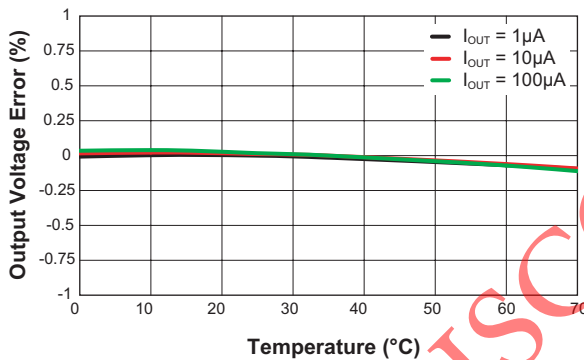

Supply Current vs. Temperature

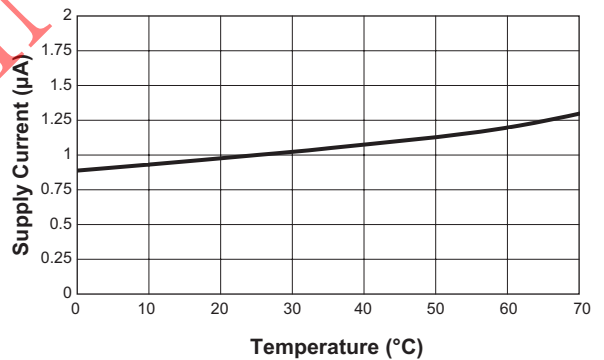

LDO Output Voltage Noise
($I_{LOAD} = 1mA$, Power BW = 100Hz to 100KHz)

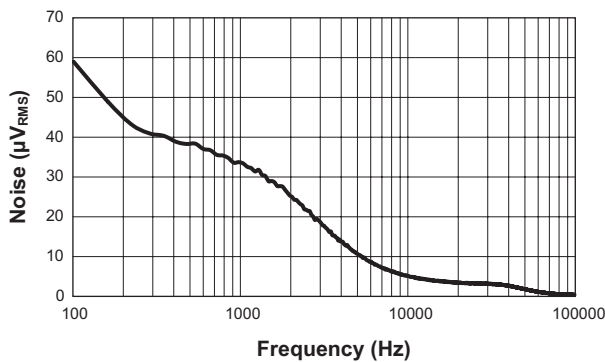

Power Supply Rejection Ratio, PSRR

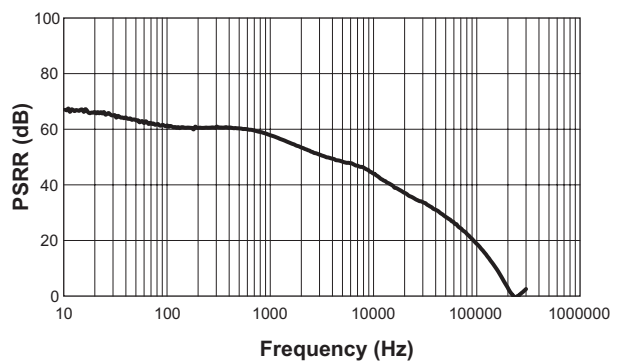

DISCONTINUED

AAT3604B

Total Power Solution for Micro Power Applications

Typical Characteristics – Buck Converter

Buck Efficiency vs. Load Current
($V_{OUT} = 1.8V$)

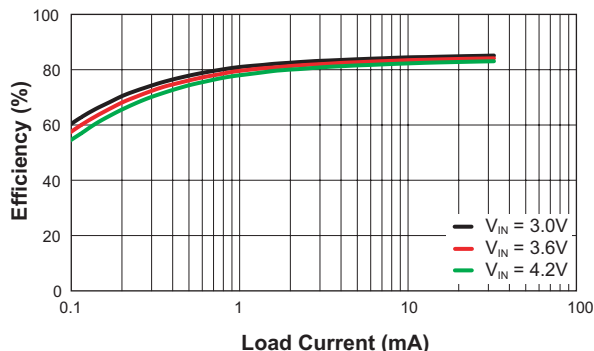

Buck Load Regulation vs. Load Current
($V_{OUT} = 1.8V$)

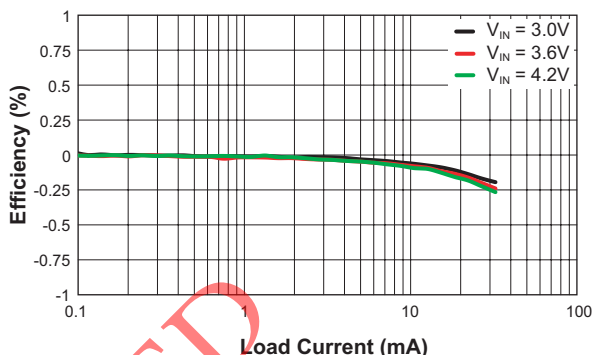

Buck Efficiency vs. Load Current
($V_{OUT} = 1.2V$)

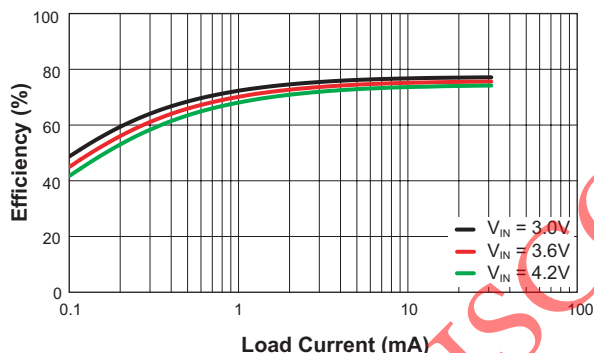

Buck Load Regulation vs. Load Current
($V_{OUT} = 1.2V$)

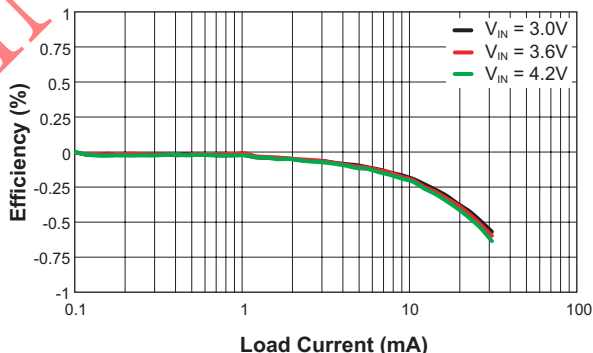

Supply Current vs. Supply Voltage
(Switching)

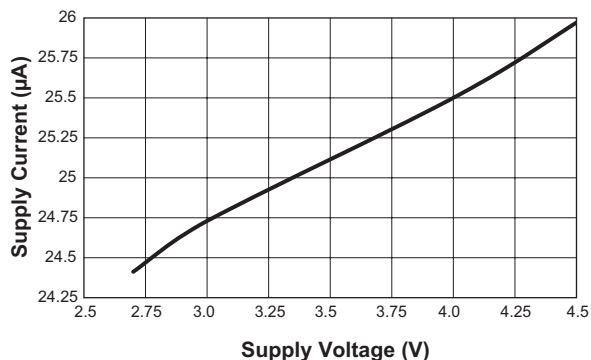

Supply Current vs. Temperature
($V_{IN} = 3.6V$; Switching)

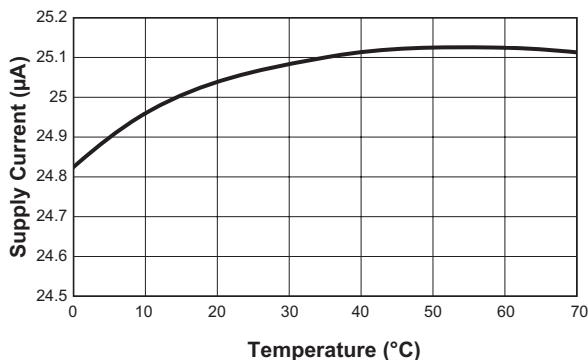

AAT3604B

Total Power Solution for Micro Power Applications

Typical Characteristics – Buck Converter

Output Voltage Error vs. Temperature

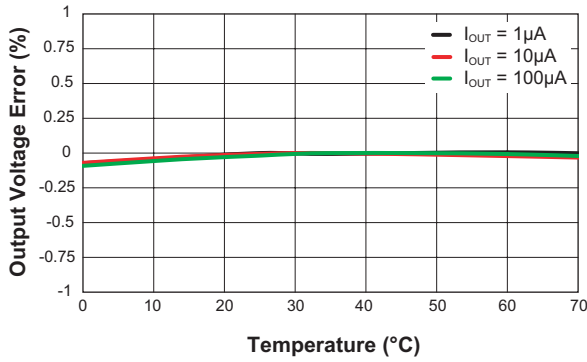

N-Channel $R_{DS(ON)}$ vs. Temperature

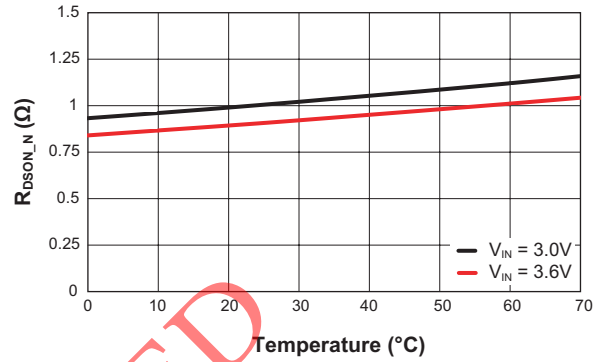

DISCONTINUED

AAT3604B

Total Power Solution for Micro Power Applications

Typical Characteristics – Boost Converter

Boost Efficiency vs. Load Current
($V_{OUT} = 27V$)

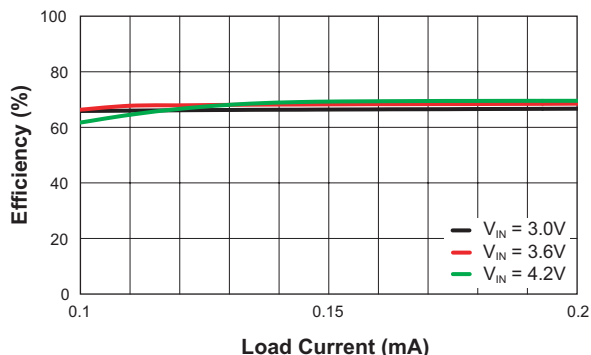

Boost Load Regulation vs. Load Current
($V_{OUT} = 27V$)

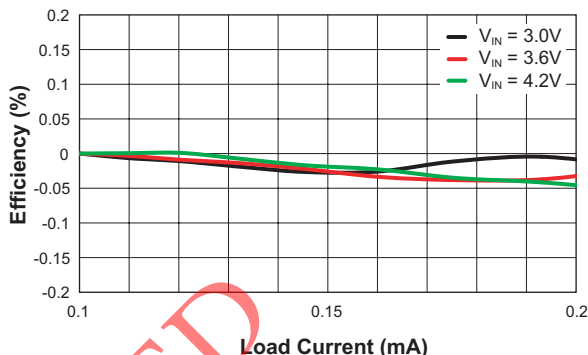

Boost Efficiency vs. Load Current
($V_{OUT} = 11V$)

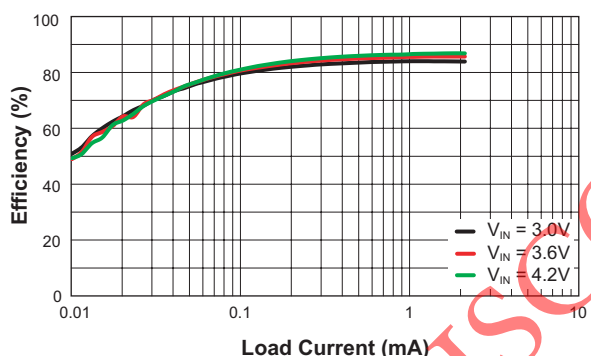

Boost Load Regulation vs. Load Current
($V_{OUT} = 11V$)

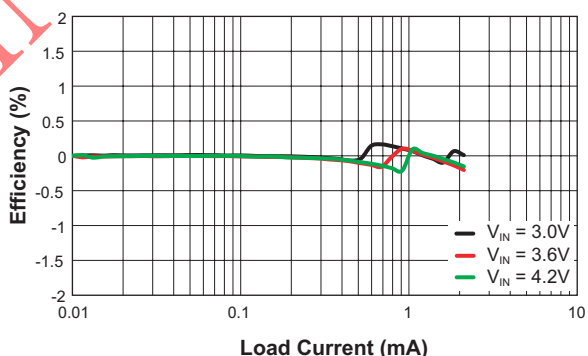

Output Voltage Error vs. Temperature

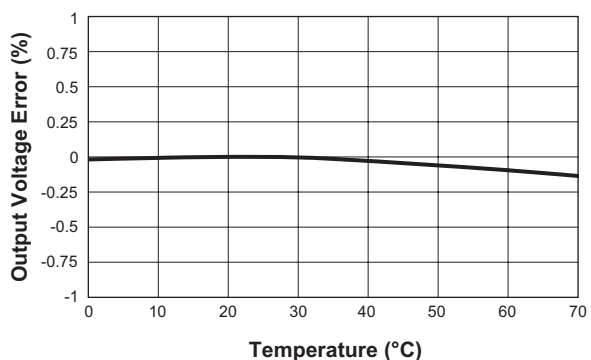

Output Voltage Error vs. Input Voltage
($V_{OUT} = 27V$)

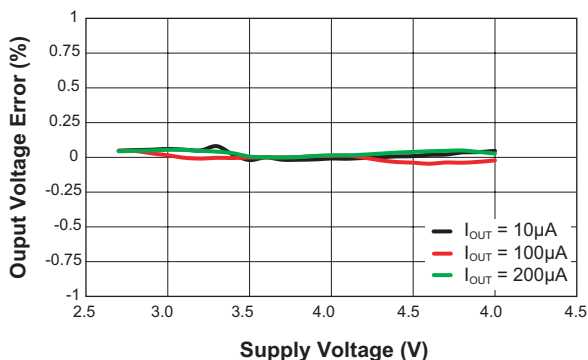

Typical Characteristics – Battery Charger

Trickle Charge to Full Charge Threshold vs. Temperature

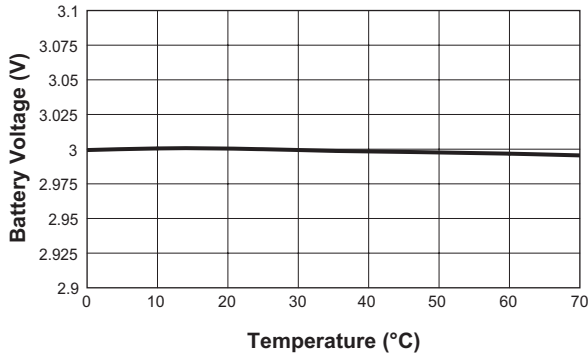

Trickle Charge to Full Charge Threshold vs. Supply Voltage

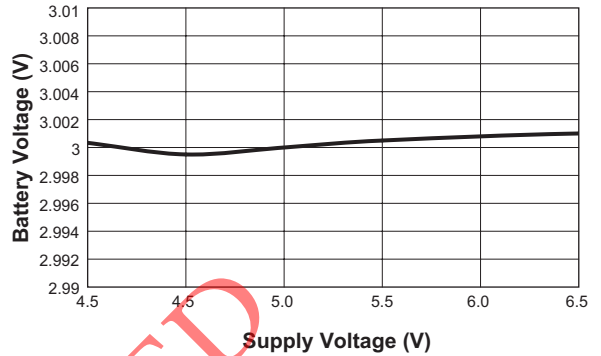

Charging Current vs. Supply Voltage

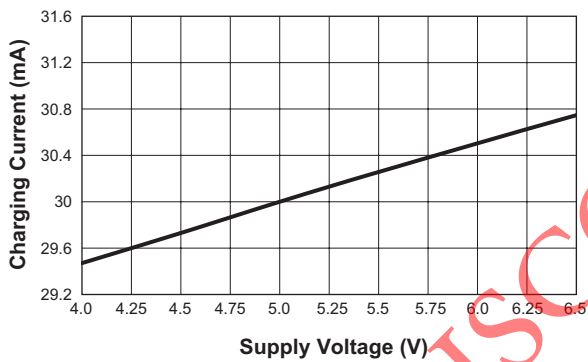

Charging Current vs. Temperature

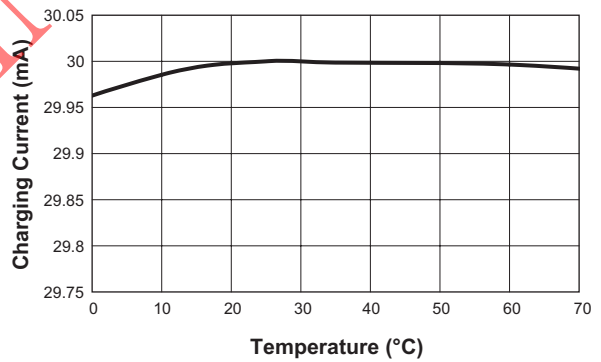

End of Charge Voltage vs. Temperature

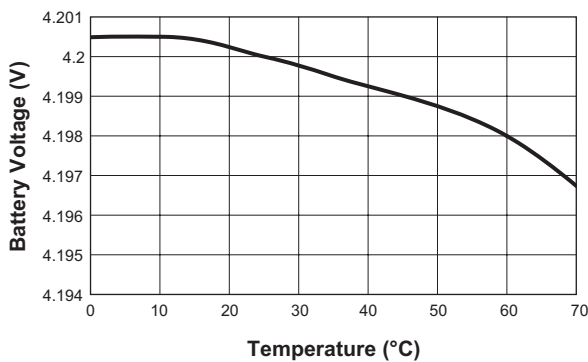

Recharge Voltage vs. Temperature

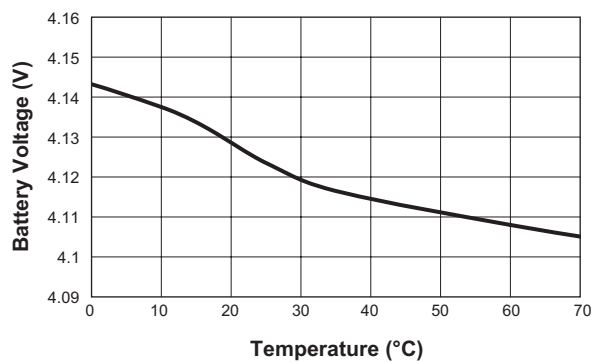

DISCONTINUED

AAT3604B

Total Power Solution for Micro Power Applications

Typical Characteristics – Battery Charger

Constant Charging Current vs. Supply Voltage
($I_{CH} = 30mA$)

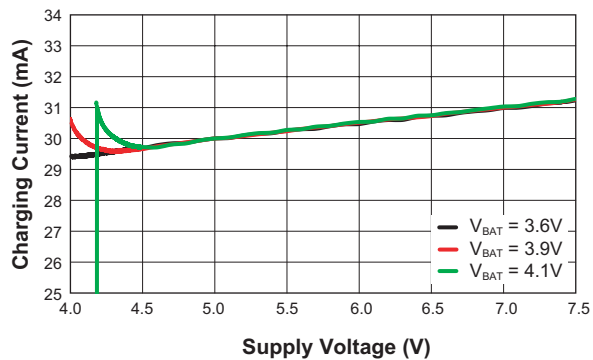

End of Charge Voltage Tolerance vs. Temperature

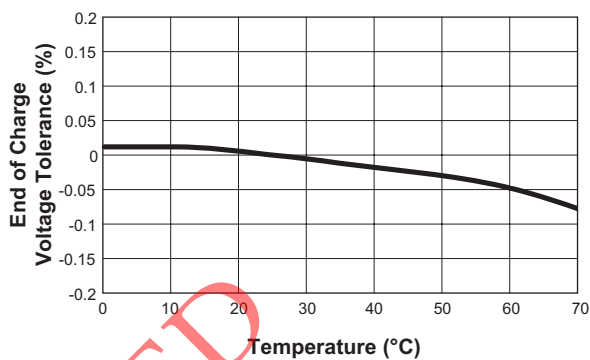

DISCONTINUED

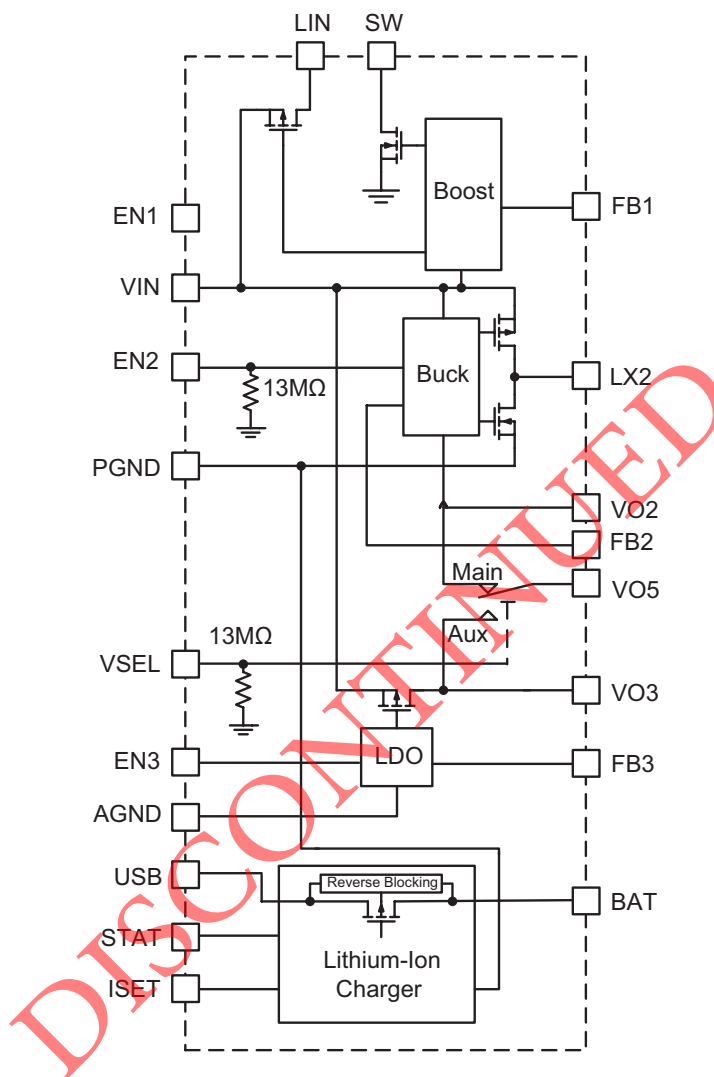
Functional Block Diagram**Functional Description**

The AAT3604B is a complete power management solution for small low power portable devices. It seamlessly integrates an intelligent, stand-alone CC/CV (Constant-Current/Constant-Voltage), linear-mode lithium-ion/polymer battery charger with a step-up (boost) converter, a step-down (buck) converter, a low-dropout (LDO) regulator, and a voltage select function to switch the core voltage for an external processor. The AAT3604B can provide charging current to the battery from a standard USB port. An internal load switch controlled by the VSEL pin allows the LDO or buck DC-DC converter to supply power to the VCORE supply pin on an external processor.

Functional Description - Lithium-Ion Polymer Battery Charger

The AAT3604B contains a low power battery charger designed to charge lithium-ion polymer batteries with up to 100mA of current from an external power source. It is a stand-alone charging solution, with just three external components required for complete functionality. The charger precisely regulates battery charge voltage and current for 4.2V lithium-ion polymer batteries. The adapter/USB charge input constant current level can be programmed up to 100mA for low power charging applications. The charger is rated for operation from 0°C to +70°C. In the event of operating ambient temperatures exceeding the power dissipation abilities of the device

Total Power Solution for Micro Power Applications

package for a given constant current charge level, the charge control will enter into thermal limit. A status monitor output pin is provided to indicate the battery charge state by directly driving an external LED. Device junction temperature and charge state are fully monitored for fault conditions. In the event of an over-voltage or over-temperature fault, the device will automatically shut down, protecting the charging device, control system, and the battery under charge.

Charging Operation

The charger has four basic modes for the battery charge cycle: pre-conditioning/trickle charge; constant current/fast charge; constant voltage; and end of charge (see Figure 1).

Battery Preconditioning

Before the start of charging, the charger checks several conditions in order to assure a safe charging environment. The input supply must be above the minimum operating voltage, or under-voltage lockout threshold (V_{UVLO}), for the charging sequence to begin. When these conditions have been met and a battery is connected to the BAT pin, the charger checks the state of the battery. If the cell voltage is below the preconditioning voltage threshold (V_{MIN}), the charge control begins preconditioning the cell. The battery preconditioning trickle charge current is equal to the fast charge constant current divided by 10. For example, if the programmed fast charge current is 50mA, then the preconditioning mode (trickle charge) current will be 5mA. Cell preconditioning is a safety precaution for deeply discharged battery cells and also aids in limiting power dissipation in the pass transistor when the voltage across the device is at the greatest potential.

Constant Current Charging

Battery cell preconditioning continues until the voltage on the BAT pin exceeds the preconditioning voltage threshold (V_{MIN}). At this point, the charger begins the constant current charging phase. The charge constant current (I_{CH}) amplitude is programmed by the user via the R_{SET} resistor. The charger remains in the constant current charge mode until the battery reaches the voltage regulation point, V_{BAT_EOC} .

Constant Voltage Charging

The system transitions to a constant voltage charging mode when the battery voltage reaches the output charge regulation threshold (V_{BAT_EOC}) during the constant current fast charge phase. The regulation voltage level is factory programmed to 4.2V ($\pm 0.5\%$). Charge current in the constant voltage mode drops as the battery cell under charge reaches its maximum capacity.

End of Charge Cycle Termination and Recharge Sequence

When the charge current drops to 10% of the programmed fast charge current level in the constant voltage mode, the device terminates charging and goes into a sleep state. The charger will remain in a sleep state until the battery voltage decreases to a level below the battery recharge voltage threshold (V_{RCH}). Consuming very low current in sleep state, the charger minimizes battery drain when it is not charging. This feature is particularly useful in applications where the input supply level may fall below the battery charge or under-voltage lockout level. In such cases where the charger input voltage drops, the device will enter sleep state and automatically resume charging once the input supply has recovered from the fault condition.

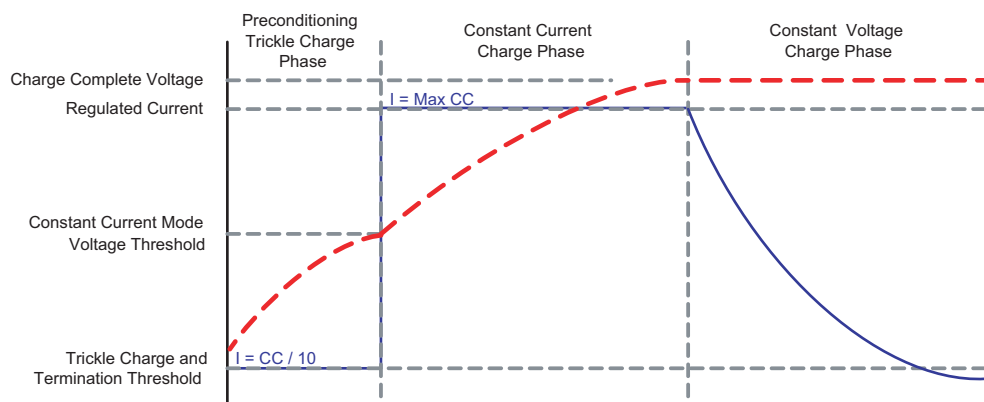
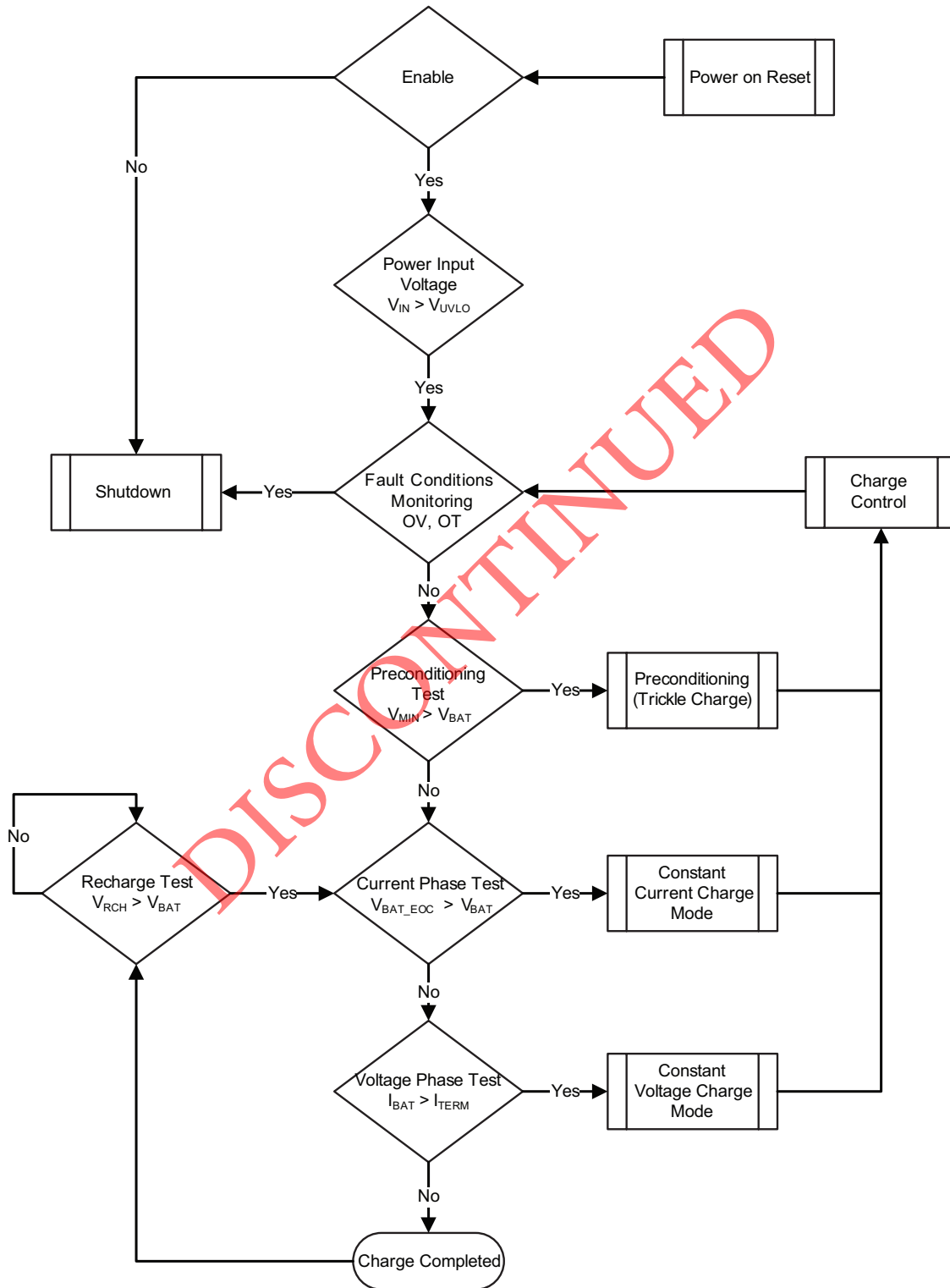

Figure 1: Current vs. Voltage Profile During Charging Phases.

System Information Flowchart



Total Power Solution for Micro Power Applications**Application Information****USB Power Input**

Constant current charge levels up to 50mA may be programmed by the user when powered from a sufficient input power source. The charger will operate from the adapter input over a 4.0V to 6.5V range. The constant current fast charge current for the adapter input is set by the R_{SET} resistor connected between I_{SET} and ground. See Table 1 for recommended R_{SET} values for a desired constant current charge level.

USB Input Charge Inhibit and Resume

The charger has a UVLO and power on reset feature so that if the input supply to the USB pin drops below the UVLO threshold, the charger will suspend charging and shut down. When power is re-applied to the USB pin or the UVLO condition recovers, the system charge control will assess the state of charge on the battery cell and will automatically resume charging in the appropriate mode for the condition of the battery.

Programming Charge Current

The fast charge constant current charge level is user programmed with a set resistor placed between the I_{SET} pin and ground. The accuracy of the fast charge, as well as the preconditioning trickle charge current, is dominated by the tolerance of the set resistor used. For this reason, a 1% tolerance metal film resistor is recommended for the set resistor function. Fast charge constant current levels from 5mA to 100mA may be set by selecting the appropriate resistor value from Table 1.

Nominal I_{CHARGE} (mA)	Set Resistor Value (k Ω)
100	2.5
85	3.0
60	4.0
50	5.11
40	6.34
30	8.45
20	12.7
10	25.5

Table 1: R_{SET} Values vs. Charge Current.**Protection Circuitry****Over-Voltage Protection**

An over-voltage event is defined as a condition where the voltage on the BAT pin exceeds the maximum battery charge voltage and is set by the over-voltage protection threshold (V_{OVP}). If an over-voltage condition occurs, the charge control will shut down the charger until voltage on the BAT pin drops below V_{OVP} . The part will resume normal charging operation after the over-voltage condition is removed.

Over-Temperature Shutdown

The AAT3604B has a thermal protection control circuit which will shut down charging functions should the internal die temperature exceed the preset thermal limit threshold. Once the internal die temperature falls below the thermal limit, normal operation will resume the previous charging state.

Charge Status Output

The AAT3604B provides battery charge status via a status pin. This pin is internally connected to an N-channel open drain MOSFET, which can be used to drive an external LED. The status pin can indicate the following conditions.

Event Description	Status
No battery charging activity	OFF
Battery charging via USB port	Blinking 1 Second, 50% Duty Cycle
Charging Completed	On

Table 2: LED Status Indicator.

The LED should be biased with as little current as necessary to create reasonable illumination; therefore, a ballast resistor should be placed between the LED cathode and the STAT pin. LED current consumption will add to the overall thermal power budget for the device package, hence it is good to keep the LED drive current to a minimum. 2mA should be sufficient to drive most low cost green or red LEDs. It is not recommended to exceed 8mA for driving an individual status LED.

AAT3604B

Total Power Solution for Micro Power Applications

The required ballast resistor values can be estimated using the following formulas:

$$R_1 = \frac{(V_{ADP} - V_{F(LED)})}{I_{LED}}$$

Example:

$$R_1 = \frac{(5.5V - 2.0V)}{2mA} = 1.75k\Omega$$

Note: Red LED forward voltage (V_F) is typically 2.0V @ 2mA.

Capacitor Selection

Input Capacitor

In general, it is good design practice to place a decoupling capacitor between the USB pin and GND. An input capacitor in the range of 2.2 μ F to 4.7 μ F is recommended. If the source supply is unregulated, it may be necessary to increase the capacitance to keep the input voltage above the under-voltage lockout threshold during device enable and when battery charging is initiated. If the AAT3604B's USB input is to be used in a system with an external power supply source, such as a typical AC-to-DC wall adapter, then a C_{IN} capacitor in the range of 10 μ F should be used. A larger input capacitor in this application will minimize switching or power transient effects when the power supply is "hot plugged" into an adapter or USB port.

Output Capacitor

The AAT3604B only requires a 1 μ F ceramic capacitor on the BAT pin to maintain circuit stability. This value should be increased to 10 μ F or more if the battery connection is made any distance from the charger output. If the AAT3604B is to be used in applications where the battery can be removed from the charger, such as with desktop charging cradles, an output capacitor greater than 10 μ F may be required to prevent the device from cycling on and off when no battery is present.

Functional Description – LDO Regulator

The AAT3604B has an LDO regulator for applications where output current load requirements range from no load to 100 μ A. The advanced circuit design of the LDO has been optimized for minimum quiescent or ground current consumption, making it ideal for use in power management systems for small battery operated devices. The typical quiescent current level is just 1 μ A. The LDO also demonstrates excellent power supply ripple rejection (PSRR) and load and line transient response characteristics. The AAT3604B contains a truly high performance LDO regulator especially well suited for circuit applications which are sensitive to load circuit power consumption and extended battery life. The LDO regulator output has been specifically optimized to function with low cost, low equivalent series resistance (ESR) ceramic capacitors. However, the design will allow for operation with a wide range of capacitor types. The LDO has complete short-circuit and thermal protection. The integral combination of these two internal protection circuits give the AAT3604B a comprehensive safety system to guard against extreme adverse operating conditions. Device power dissipation is limited to the package type and thermal dissipation properties. Refer to the Thermal Considerations section of this datasheet for details on device operation at maximum output load levels.

Output Voltage Programming

The output voltage may be programmed through a resistor divider network located from the output capacitor to the FB3 pin to ground.

Applications Information

Input Capacitor

The C_{IN} capacitor is shared with the boost converter and buck converter. C_{IN} should be located as close to the device VIN pin as practically possible. Typically, a 2.2 μ F or larger capacitor is recommended for C_{IN} in most applications. C_{IN} values greater than 2.2 μ F will offer superior input line transient response and will assist in maximizing the highest possible power supply ripple rejection. Ceramic, tantalum, or aluminum electrolytic capacitors may be selected for C_{IN} . There is no specific capacitor ESR requirement for C_{IN} . For LDO regulator output operation, ceramic capacitors are recommended for C_{IN} due to their inherent capability over tantalum capacitors to

Total Power Solution for Micro Power Applications

withstand input current surges from low-impedance sources such as batteries in portable devices.

Output Capacitor

For proper load voltage regulation and operational stability, a capacitor is required between pins VO3 and GND. The C_{OUT} capacitor connection to the LDO regulator ground pin should be as direct as practically possible for maximum device performance. The LDO has been specifically designed to function with very low ESR ceramic capacitors. Although the AAT3604B is intended to operate with low ESR capacitors, it is stable over a very wide range of capacitor ESR, thus it will also work with some higher ESR tantalum or aluminum electrolytic capacitors. However, for best performance, ceramic capacitors are recommended. The value of C_{OUT} typically ranges from 0.47μF to 10μF; however, 1μF is sufficient for most operating conditions.

If large output current steps are required by an application, then an increased value for C_{OUT} should be considered. The amount of capacitance needed can be calculated from the step size of the change in the output load current expected and the voltage excursion that the load can tolerate. The total output capacitance required can be calculated using the following formula:

$$C_{OUT} = \frac{\Delta I}{\Delta V} \cdot 15\mu F$$

Where:

ΔI = maximum step in output current

ΔV = maximum excursion in voltage that the load can tolerate.

Note that use of this equation results in capacitor values approximately two to four times the typical value needed for the LDO at room temperature. The increased capacitor value is recommended if tight output tolerances must be maintained over extreme operating conditions and maximum operational temperature excursions. If tantalum or aluminum electrolytic capacitors are used, the capacitor value should be increased to compensate for the substantial ESR inherent to these capacitor types.

Capacitor Characteristics

Ceramic composition capacitors are highly recommended over all other types of capacitors for use with the LDO. Ceramic capacitors offer many advantages over their tan-

talum and aluminum electrolytic counterparts. A ceramic capacitor typically has very low ESR, is lower cost, has a smaller PCB footprint, and is non-polarized. Line and load transient response of the LDO regulator is improved by using low ESR ceramic capacitors. Since ceramic capacitors are non-polarized, they are less prone to damage if incorrectly connected.

Equivalent Series Resistance

ESR is a very important characteristic to consider when selecting a capacitor. ESR is the internal series resistance associated with a capacitor that includes lead resistance, internal connections, capacitor size and area, material composition, and ambient temperature. Typically, capacitor ESR is measured in milliohms for ceramic capacitors and can range to more than several ohms for tantalum or aluminum electrolytic capacitors.

Ceramic Capacitor Materials

Ceramic capacitors less than 0.1μF are typically made from NPO or C0G materials. NPO and C0G materials generally have tight tolerance and are very stable over temperature. Larger capacitor values are usually composed of X7R, X5R, Z5U, or Y5V dielectric materials. Large ceramic capacitors (i.e., greater than 2.2μF) are often available in low-cost Y5V and Z5U dielectrics. These two material types are not recommended for use with LDO regulators since the capacitor tolerance can vary by more than ±50% over the operating temperature range of the device. A 2.2μF Y5V capacitor could be reduced to 1μF over the full operating temperature range. This can cause problems for circuit operation and stability. X7R and X5R dielectrics are much more desirable. The temperature tolerance of X7R dielectric is better than ±15%. Capacitor area is another contributor to ESR. Capacitors, which are physically large in size will have a lower ESR when compared to a smaller sized capacitor of equivalent material and capacitance value. These larger devices can also improve circuit transient response when compared to an equal value capacitor in a smaller package size. Consult capacitor vendor datasheets carefully when selecting capacitors for use with LDO regulators.

Feedback Resistor Selection

Resistors R1 and R2 of Figure 2 program the output to regulate at a voltage higher than 1.0V. To limit the bias current required for the external feedback resistor string while maintaining good noise immunity, the minimum

Total Power Solution for Micro Power Applications

suggested value for R6 is 1.0MΩ. $V_{FB} = 1.0V$ for the LDO. Although a larger value will further reduce quiescent current, it will also increase the impedance of the feedback node, making it more sensitive to external noise and interference. Table 3 summarizes the resistor values for various output voltages with R2 set to either 1.02MΩ for reduced no load input current.

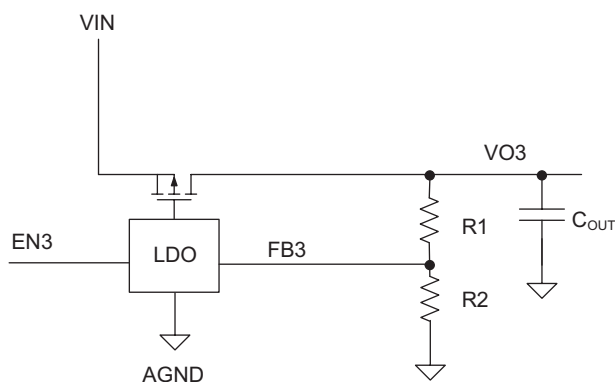

Figure 2: LDO Regulator External Feedback.

$$R1 = \left[\left(\frac{V_{OUT}}{V_{FB}} \right) - 1 \right] \cdot R2$$

V_{OUT}	R1 (Ω)	R2 (Ω)
2.0V	1.00M	1.00M
2.1V	1.10M	1.00M
2.2V	1.21M	1.00M
2.3V	1.30M	1.00M
2.4V	1.40M	1.00M
2.5V	1.50M	1.00M
2.6V	1.62M	1.00M

Table 3: LDO Feedback Resistor Values.

No-Load Stability

The LDO is designed to maintain output voltage regulation and stability under operational no load conditions. This is an important characteristic for applications where the output current may drop to zero. An output capacitor is required for stability under no-load operating conditions. Refer to the Output Capacitor section of this datasheet for recommended typical output capacitor values.

Functional Description – Boost Controller

The DC/DC boost controller contains an integrated slew rate controlled input disconnect MOSFET switch, and a MOSFET power switch. A high voltage rectifier, power inductor, output capacitor, and resistor divider network are required to implement a DC/DC boost converter.

Control Loop

The AAT3604B provides the benefits of current mode control with a simple hysteretic feedback loop. The device maintains exceptional DC regulation, transient response, and cycle-by-cycle current limit without additional compensation components. The boost converter modulates the power MOSFET switching current in response to changes in output voltage. This allows the voltage loop to directly program the required inductor current in response to changes in the output load.

The switching cycle initiates when the N-channel MOSFET is turned ON and current ramps up in the inductor. The ON interval is terminated when the inductor current reaches the programmed peak current level. During the OFF interval, the input current decays until the lower threshold, or zero inductor current, is reached. The lower current is equal to the peak current minus a preset hysteresis threshold - which determines the inductor ripple current. The peak current is adjusted by the controller until the output current requirement is met.

The magnitude of the feedback error signal determines the average input current. Therefore, the boost controller implements a programmed current source connected to the output capacitor and load resistor. There is no right-half plane zero, and loop stability is easily achieved with no additional compensation components. Increased load current results in a drop in the output feedback voltage (FB1) sensed through the feedback resistors (R1, R2). The controller responds by increasing the peak inductor current, resulting in higher average current in the inductor. Alternatively, decreased output load results in an increase in the output feedback voltage (FB1 pin). The controller responds by decreasing the peak inductor current, resulting in lower average current in the inductor.

The AAT3604B uses light load mode operation to reduce switching losses and maintain high efficiency.

Operating frequency varies with changes in the input voltage, output voltage, and inductor size. A small 10μH (±20%) inductor is selected to maintain high efficiency operation for 27V output at 200uA.

Total Power Solution for Micro Power Applications**Output Voltage Programming**

The output voltage may be programmed through a resistor divider network located from the output capacitor to the FB1 pin to ground. The range is 6V to 27V.

Soft Start / Enable

The input disconnect switch is activated when a valid input voltage is present and the EN1 pin is pulled high. The slew rate control on the P-channel MOSFET ensures minimal inrush current as the output voltage is charged to the input voltage, prior to switching of the N-channel power MOSFET. Monotonic turn-on is guaranteed by the built in soft-start circuitry. Soft-start eliminates output voltage overshoot across the full input voltage range and all loading conditions. Some applications may require the output to be active when a valid input voltage is present. In these cases, tie EN1 to VIN.

Current Limit and Over-Temperature Protection

The switching of the N-channel MOSFET terminates when current limit of 250mA (typical) is exceeded. This minimizes power dissipation and component stresses under overload and short-circuit conditions. Switching resumes when the current decays below the current limit. Thermal protection disables the boost converter when internal dissipation becomes excessive. Thermal protection disables both MOSFETs. The junction over-temperature threshold is 140°C with 25°C of temperature hysteresis. Once an over-temperature or over-current fault condition is removed, the output voltage automatically recovers.

Under-Voltage Lockout

Internal bias of all circuits is controlled via the VIN input. Under-voltage lockout (UVLO) guarantees sufficient VIN bias and proper operation of all internal circuitry prior to activation.

Application Information**Selecting DC/DC Boost Capacitors**

The high output ripple inherent in the boost converter necessitates low impedance output filtering. Multi-layer ceramic (MLC) capacitors provide small size and adequate capacitance, low parasitic equivalent series resistance (ESR) and equivalent series inductance (ESL), and are well suited for use with the AAT3604B boost regulator. MLC capacitors of type X7R or X5R are recommended to ensure good capacitance stability over the full operating temperature range. The output capacitor is

sized to maintain the output load without significant voltage droop during the power switch ON interval, when the output diode is not conducting. A ceramic output capacitor of 2.2 μ F is recommended. Typically, 30V rated ceramic capacitors are required for the 27V boost output. Ceramic capacitors sized as small as 0603 are available which meet these requirements. MLC capacitors exhibit significant capacitance reduction with applied voltage. Output ripple measurements should confirm that output voltage droop is acceptable.

The boost converter input current flows during both ON and OFF switching intervals. The input ripple current is less than the output ripple and, as a result, less input capacitance is required. The C_{IN} capacitor is shared with the LDO regulator and buck converter. A ceramic input capacitor from 2.2 μ F to 3.3 μ F is recommended. Minimum 6.3V rated ceramic capacitors are required at the input. Ceramic capacitors sized as small as 0603 are available which meet these requirements.

Large capacitance tantalum or solid-electrolytic capacitors may be necessary to meet stringent output ripple and transient load requirements. These can replace (or be used in parallel with) ceramic capacitors. Both tantalum and OSCON-type capacitors are suitable due to their low ESR and excellent temperature stability (although they exhibit much higher ESR than MLC capacitors). Aluminum-electrolytic types are less suitable due to their high ESR characteristics and temperature drift. Unlike MLC capacitors, these types are polarized and proper orientation on input and output pins is required. 30% to 70% voltage derating is recommended for tantalum capacitors.

Selecting the Output Diode

To ensure minimum forward voltage drop and no recovery, high voltage Schottky diodes are considered the best choice for the AAT3604B boost converter. The output diode is sized to maintain acceptable efficiency and reasonable operating junction temperature under cycle by cycle operating conditions. Forward voltage (V_F), reverse leakage and package thermal resistance (θ_{JA}) are the dominant factors to consider in selecting a diode. The diode's published current rating may not reflect actual operating conditions and should be used only as a comparative measure between similarly rated devices. 20V rated Schottky diodes are recommended for outputs less than 15V, while 30V rated Schottky diodes are recommended for outputs greater than 15V and 40V for outputs greater than 25V. The average diode current is equal to the output current.

Total Power Solution for Micro Power Applications

$$I_{AVG} = I_{OUT}$$

The average output current multiplied by the forward diode voltage determines the loss of the output diode.

$$\begin{aligned} P_{LOSS_DIODE} &= I_{AVG} \cdot V_F \\ &= I_{OUT} \cdot V_F \end{aligned}$$

Diode junction temperature can be estimated.

$$T_J = T_{AMB} + \theta_{JA} \cdot P_{LOSS_DIODE}$$

The junction temperature should be maintained below 110°C, but may vary depending on application and/or system guidelines. The diode θ_{JA} can be minimized with additional PCB area on the cathode. PCB heatsinking the anode may degrade EMI performance. The reverse leakage current of the rectifier must be considered to maintain low quiescent (input) current and high efficiency under light load. The rectifier reverse current increases dramatically at high temperatures. For 27V outputs at 200uA, the Diodes, Inc. SD103BWS is recommended. For less than 20V outputs, the Diodes, Inc. SD103CWS can be used.

Selecting the Boost Inductor

An output inductor sized from 5.6μH to 10μH is recommended. The RMS current flowing through the boost inductor is equal to the DC plus AC ripple components. Under worst-case RMS conditions, the current waveform is critically continuous. The resulting RMS calculation yields worst-case inductor loss. The RMS value should be compared against the manufacturer's temperature rise, or thermal derating, guidelines.

$$I_{RMS} = \frac{I_{PEAK}}{\sqrt{3}}$$

For a given inductor type, smaller inductor size leads to an increase in DCR winding resistance and, in most cases, increased thermal impedance. Winding resistance degrades boost converter efficiency and increases the inductor operating temperature.

$$P_{LOSS_INDUCTOR} = I_{RMS}^2 \cdot DCR$$

To ensure high reliability, the inductor temperature should not exceed 100°C. Manufacturer's recommendations should be consulted. Shielded inductors provide decreased EMI and may be required in noise sensitive applications. Unshielded chip inductors provide significant space savings at a reduced cost compared to shielded (wound and gapped) inductors. Chip-type inductors have increased winding resistance when compared to shielded, wound varieties. The Coiltronics SD3110-3R3-R 3.3μH inductor is recommended for a 10V output, the Coilcraft LPO6610-103ML 10μH inductor is recommended for a 19V output and the Sumida CDRH2D09NP-5R6MV 5.6μH inductor is recommended for 27V output.

Setting the Adjustable Output Voltage

The output voltage may be programmed through a resistor divider network located from the output to FB pin to ground.

The output voltage of the boost switching regulator (V_{OUT}) is determined by the following equation:

$$V_{OUT} = V_{FB} \left(1 + \frac{R1}{R2} \right)$$

$$R1 = \left[\left(\frac{V_{OUT}}{V_{FB}} \right) - 1 \right] \cdot R2$$

Where $V_{FB} = 1.0V$ for the boost converter.

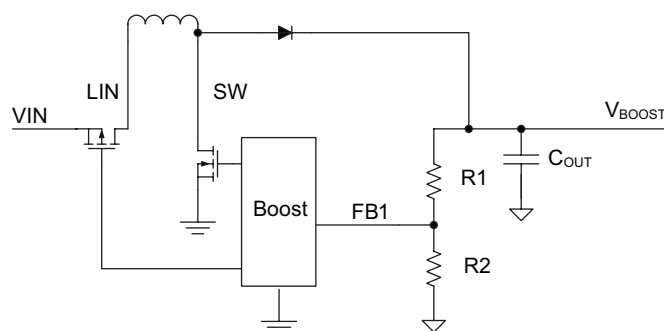

Figure 3: Boost Converter External Feedback.

Total Power Solution for Micro Power Applications**Functional Description – Buck Converter**

The buck converter is a high performance 25mA monolithic step-down converter. It minimizes external component size, enabling the use of a tiny 0603 inductor that is only 1mm tall, and optimizes efficiency over the complete load range. Apart from the small bypass input capacitor, only a small L-C filter is required at the output. Typically, a 2.2 μ H inductor and a 1 μ F ceramic capacitor are recommended (see table of values). Only three external power components (C_{IN} , C_{OUT} , and L) are required. The C_{IN} capacitor is shared with the boost converter and LDO regulator. Output voltage is set internally at 1.8V. At dropout, the converter duty cycle increases to 100% and the output voltage tracks the input voltage minus the $R_{DS(ON)}$ drop of the P-channel high-side MOSFET. The input voltage range is 2.7V to 5.5V. The converter efficiency has been optimized for all load conditions, ranging from no load to 5mA. The internal error amplifier and compensation provides excellent transient response, load, and line regulation. Soft start eliminates any output voltage overshoot when the enable or the input voltage is applied.

Control Loop

The buck converter is a peak current mode step-down converter. The current through the P-channel MOSFET (high side) is sensed for current loop control, as well as short circuit and overload protection. A fixed slope compensation signal is added to the sensed current to maintain stability for duty cycles greater than 50%. The peak current mode loop appears as a voltage programmed current source in parallel with the output capacitor. The output of the voltage error amplifier programs the current mode loop for the necessary peak switch current to force a constant output voltage for all load and line conditions. Internal loop compensation terminates the transconductance voltage error amplifier output.

Soft Start / Enable

Soft start limits the current surge seen at the input and eliminates output voltage overshoot. When pulled low, the enable input forces the buck converter into a low-power, non-switching state. The total input current during shutdown is less than 1 μ A.

Current Limit and Over-Temperature Protection

For overload conditions, the peak input current is limited. To minimize power dissipation and stresses under current limit and short-circuit conditions, switching is terminated after entering current limit for a series of pulses. Switching is terminated for seven consecutive clock cycles after a current limit has been sensed for a series of four consecutive clock cycles. Thermal protection completely disables switching when internal dissipation becomes excessive. The junction over-temperature threshold is 140°C with 15°C of hysteresis. Once an over-temperature or over-current fault conditions is removed, the output voltage automatically recovers.

Applications Information**Inductor Selection**

The step-down converter uses peak current mode control with slope compensation to maintain stability for duty cycles greater than 50%. The output inductor value must be selected so the inductor current down slope meets the internal slope compensation requirements. Table 1 displays suggested inductor values for various output voltages. Manufacturer's specifications list both the inductor DC current rating, which is a thermal limitation, and the peak current rating, which is determined by the saturation characteristics. The inductor should not show any appreciable saturation under normal load conditions. Some inductors may meet the peak and average current ratings yet result in excessive losses due to a high DCR. Always consider the losses associated with the DCR and its effect on the total converter efficiency when selecting an inductor.

The 2.2 μ H LQM21P series inductor selected from Murata has a 340mW DCR and a 600mA saturation current rating. At full load, the inductor DC loss is 8.5 μ W which gives a 0.1% loss in efficiency for a 5mA, 1.8V output.

Input Capacitor

Select a 2.2 μ F to 4.7 μ F X7R or X5R ceramic capacitor for the input since the C_{IN} capacitor is shared with the boost converter and LDO regulator.

Total Power Solution for Micro Power Applications

Output Capacitor

The output capacitor limits the output ripple and provides holdup during large load transitions. A 1 μ F to 2.2 μ F X5R or X7R ceramic capacitor typically provides sufficient bulk capacitance to stabilize the output during large load transitions and has the ESR and ESL characteristics necessary for low output ripple.

The output voltage droop due to a load transient is dominated by the capacitance of the ceramic output capacitor. During a step increase in load current, the ceramic output capacitor alone supplies the load current until the loop responds. Within two or three switching cycles, the loop responds and the inductor current increases to match the load current demand. The relationship of the output voltage droop during the three switching cycles to the output capacitance can be estimated by:

$$C_{OUT} = \frac{3 \cdot \Delta I_{LOAD}}{V_{DROOP} \cdot F_S}$$

Once the average inductor current increases to the DC load level, the output voltage recovers. The above equation establishes a limit on the minimum value for the output capacitor with respect to load transients. The internal voltage loop compensation also limits the minimum output capacitor value to 1 μ F. This is due to its effect on the loop crossover frequency (bandwidth), phase margin, and gain margin. Increased output capacitance will reduce the crossover frequency with greater phase margin.

The maximum output capacitor RMS ripple current is given by:

$$I_{RMS(MAX)} = \frac{1}{2 \cdot \sqrt{3}} \cdot \frac{V_{OUT} \cdot (V_{IN(MAX)} - V_{OUT})}{L \cdot F_S \cdot V_{IN(MAX)}}$$

Dissipation due to the RMS current in the ceramic output capacitor ESR is typically minimal, resulting in less than a few degrees rise in hot-spot temperature.

$$T_{J(MAX)} = P_{TOTAL} \cdot \Theta_{JA} + T_{AMB}$$

Setting the Adjustable Output Voltage

The output voltage may be programmed through a resistor divider network located from the output to FB pin to ground. An external resistor divider is used to set the output voltage as shown in Figure 4.

The output voltage of the buck switching regulator (V_{OUT}) is determined by the following equation:

$$V_{OUT} = V_{FB} \left(1 + \frac{R1}{R2} \right)$$

$$R1 = \left[\left(\frac{V_{OUT}}{V_{FB}} \right) - 1 \right] \cdot R2$$

Where $V_{FB} = 0.6V$ for the buck converter.

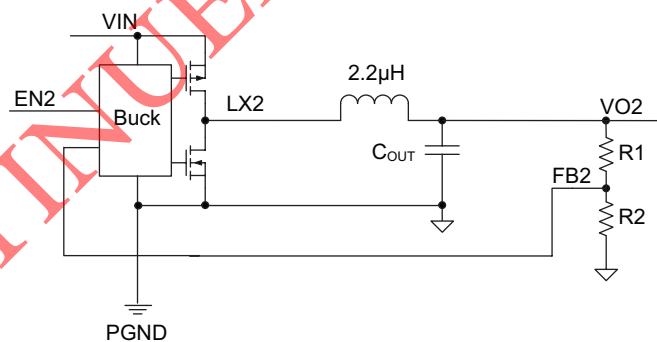

Figure 4: Buck Converter External Feedback.

Functional Description – VCORE Switch

An internal load switch controlled by the VSEL pin allows the LDO regulator or buck DC-DC converter to supply power to the VO5 output for a VCORE supply pin of an external processor core voltage. The load switch is for dynamic power path/sleep mode operation for ultra low power portable devices. With VSEL low, the VO3 supply is connected to VO5. When VSEL is high, the VO2 supply is connected to VO5. The maximum output current is 25mA.

Ordering Information

Package	Voltage			Marking ¹	Part Number (Tape & Reel) ²
	Boost	Buck	LDO		
QFN44-24	Adjustable	Adjustable	Adjustable	S9XY	AAT3604BISK-T1



Skyworks Green™ products are compliant with all applicable legislation and are halogen-free.

For additional information, refer to *Skyworks Definition of Green™*, document number SQ04-0074.

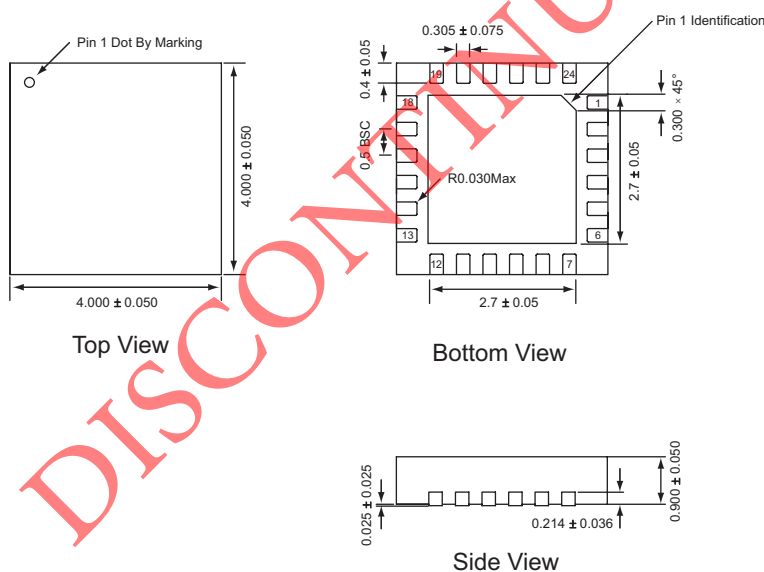
Package Information**QFN44-24³**

All dimensions in millimeters.

1. XYY = assembly and date code.

2. Sample stock is generally held on part numbers listed in **BOLD**.

3. The leadless package family, which includes QFN, TQFN, DFN, TDFN and STDN, has exposed copper (unplated) at the end of the lead terminals due to the manufacturing process. A solder fillet at the exposed copper edge cannot be guaranteed and is not required to ensure a proper bottom solder connection.

Total Power Solution for Micro Power Applications

DISCONTINUED

Copyright © 2012 Skyworks Solutions, Inc. All Rights Reserved.

Information in this document is provided in connection with Skyworks Solutions, Inc. ("Skyworks") products or services. These materials, including the information contained herein, are provided by Skyworks as a service to its customers and may be used for informational purposes only by the customer. Skyworks assumes no responsibility for errors or omissions in these materials or the information contained herein. Skyworks may change its documentation, products, services, specifications or product descriptions at any time, without notice. Skyworks makes no commitment to update the materials or information and shall have no responsibility whatsoever for conflicts, incompatibilities, or other difficulties arising from any future changes.

No license, whether express, implied, by estoppel or otherwise, is granted to any intellectual property rights by this document. Skyworks assumes no liability for any materials, products or information provided hereunder, including the sale, distribution, reproduction or use of Skyworks products, information or materials, except as may be provided in Skyworks Terms and Conditions of Sale.

THE MATERIALS, PRODUCTS AND INFORMATION ARE PROVIDED "AS IS" WITHOUT WARRANTY OF ANY KIND, WHETHER EXPRESS, IMPLIED, STATUTORY, OR OTHERWISE, INCLUDING FITNESS FOR A PARTICULAR PURPOSE OR USE, MERCHANTABILITY, PERFORMANCE, QUALITY OR NON-INFRINGEMENT OF ANY INTELLECTUAL PROPERTY RIGHT; ALL SUCH WARRANTIES ARE HEREBY EXPRESSLY DISCLAIMED. SKYWORKS DOES NOT WARRANT THE ACCURACY OR COMPLETENESS OF THE INFORMATION, TEXT, GRAPHICS OR OTHER ITEMS CONTAINED WITHIN THESE MATERIALS. SKYWORKS SHALL NOT BE LIABLE FOR ANY DAMAGES, INCLUDING BUT NOT LIMITED TO ANY SPECIAL, INDIRECT, INCIDENTAL, STATUTORY, OR CONSEQUENTIAL DAMAGES, INCLUDING WITHOUT LIMITATION, LOST REVENUES OR LOST PROFITS THAT MAY RESULT FROM THE USE OF THE MATERIALS OR INFORMATION, WHETHER OR NOT THE RECIPIENT OF MATERIALS HAS BEEN ADVISED OF THE POSSIBILITY OF SUCH DAMAGE.

Skyworks products are not intended for use in medical, lifesaving or life-sustaining applications, or other equipment in which the failure of the Skyworks products could lead to personal injury, death, physical or environmental damage. Skyworks customers using or selling Skyworks products for use in such applications do so at their own risk and agree to fully indemnify Skyworks for any damages resulting from such improper use or sale.

Customers are responsible for their products and applications using Skyworks products, which may deviate from published specifications as a result of design defects, errors, or operation of products outside of published parameters or design specifications. Customers should include design and operating safeguards to minimize these and other risks. Skyworks assumes no liability for applications assistance, customer product design, or damage to any equipment resulting from the use of Skyworks products outside of stated published specifications or parameters.

Skyworks, the Skyworks symbol, and "Breakthrough Simplicity" are trademarks or registered trademarks of Skyworks Solutions, Inc., in the United States and other countries. Third-party brands and names are for identification purposes only, and are the property of their respective owners. Additional information, including relevant terms and conditions, posted at www.skyworksinc.com, are incorporated by reference.